

INSULATED STAINLESS STEEL SUPER DUTY HOT CABINET SERIES

FEATURES AND BENEFITS:

- Fully insulated hot cabinet keeps prepared foods at safe serving temperatures.
- Available in Full Size, 3/4 Size or half size units with locking universal transport angles accommodate a variety of pan sizes on adjustable 1-1/2" centers.
- Powerful, yet efficient, 1500 Watt heating system maintains the right temperature to properly hold products. Heats up to 200°F (93°C).
- Standard solid state electronic control with large, clear, easy-to-read and operate LED digital display to ensure holding at precise food temperature.
- Internal frame in body maintains structural rigidity.
- Full perimeter bumper, rear push/pull handle and dry erase panel come standard on all models.
- Stainless steel construction throughout for ease of cleaning. One piece extended base protects cabinet body.
- Super duty composite side impact panel protection with ergonomic grips on both sides prevents damage to walls; allows for easy maneuvering.
- Insulated Dutch doors prevent temperature loss. Standard with right hand hinging; left hand hinging available upon request.
- Lockable slide bolt door latches ensure the doors stay closed even during the roughest transport.
- Smooth interior coved corners prevent food particle/grease buildup.
- Heavy duty 6" modulus casters, two with brakes. Provides mobility when fully loaded.



H-137-SUA-12D-SD



Standard solid state electronic control with large, clear, easy-to-read and operate LED digital display to ensure holding at precise food temperature

ACCESSORIES and OPTIONS (Available at extra cost):

- Extra Transport Angles
- 208 or 240 Volt Service
- Upgrade to 2000 Watt Power Unit

See page B-30 for accessory details.



H-137-SD SERIES

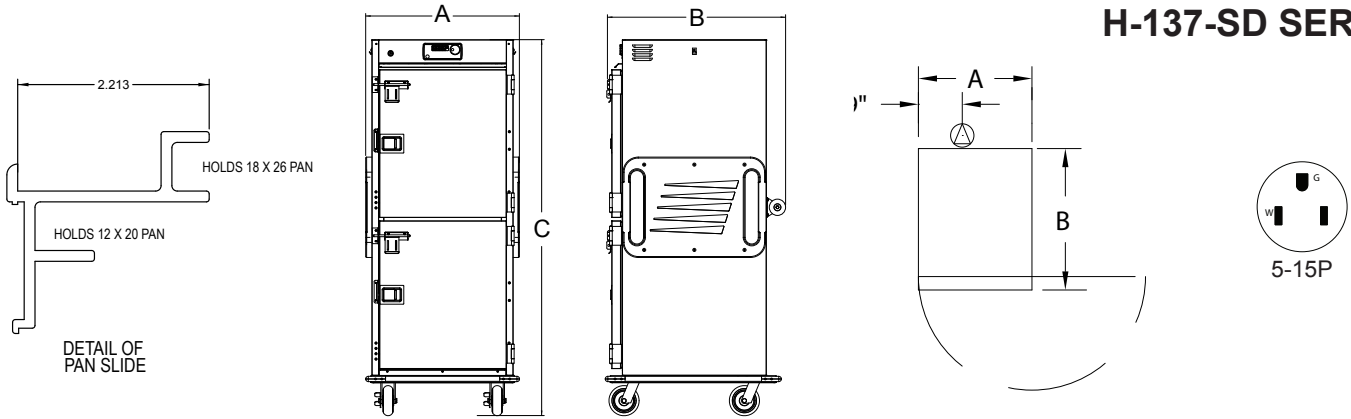

CRES COR MODEL NO.	ANGLES	CAPACITY/ PAN SIZE		DIM			INSIDE DIMENSIONS				WEIGHT ACT.
				WIDTH	DEPTH	HEIGHT	WIDTH	DEPTH	HEIGHT		
H-137-SUA-12D-SD	12 SETS	(12) 18 x 26 or (24) 12 x 20	IN	30-1/2	34-7/8	74-3/8	22	26-7/8	58	LBS	374
			MM	775	885	1890	560	685	1475	KG	170
H-137-SUA-9D-SD	9 SETS	(9) 18 x 26 or (18) 12 x 20	IN	30-1/2	34-7/8	58-5/8	22	26-7/8	42	LBS	312
			MM	775	885	1490	560	685	1070	KG	142
H-137-SUA-6D-SD	6 SETS	(6) 18 x 26 or (12) 12 x 20	IN	30-1/2	34-7/8	44-3/8	22	26-7/8	28	LBS	262
			MM	775	885	1130	560	685	715	KG	118



Gold indicates our Best Insulated Hot Cabinets with the best warranty in the industry.
3-Year Parts / 1-Year Labor.

CABINET:

- Body: 22 ga. stainless steel.
- Reinforcement: Internal framework of 18 ga. 304 stainless steel.
- Insulation: Fiberglass, thermal conductivity (K factor) is .23 at 75°F. 1-1/2" in doors, base top; 2" in sidewalls.
- Air tunnels: 22 ga. stainless steel; lift-out type, mounted on sides.
- Push/pull handle: Welded stainless steel with end bumpers; rear mounted.
- Interior coved corners.
- Super Duty composite side impact panel with ergonomic grips.
- Supplied with magnetic white erasable board, 12" x 12".

BASE:

- One piece construction, .125 aluminum; extended in rear for toe kick.
- Casters: 6" dia., modulus tires, 2" wide, load cap. 450 lbs. each, temp. range -40°/+180°F. Sealed ball bearings; permanently lubricated. Front casters equipped with brakes.
- Perimeter bumper: 1" non-marking gray rubber.

DUTCH DOORS:

- Formed 22 ga. stainless steel.
- Hinges: 11 ga. stainless steel, butt type.
- Gaskets: Perimeter type, silicone.
- Pan stop: Embossed.
- Latches: Polished stainless steel, slam type; flush mounted.
- Transport Latch: 12 ga. stainless steel slide with lockable hasp.

TRANSPORT PAN SLIDES:

- Extruded aluminum; mounted on locking lift-off posts.
- Spaced on 4-1/2" centers; adjustable on 1-1/2" centers.

HOT UNIT COMPONENTS:

- Thermostat: Solid state digital display control, room ambient to 200°F (93°C).
- Switch: ON-OFF push button type.
- Power cord: Permanent, 10 ft., 14/3 ga.
- Heater: 1470 Watts (960 Watts for -UA6D)
- Blower motor.
- Vent Fan.
- Thermometer: Digital.

POWER REQUIREMENTS:

- For H137SUA9D and H137SUA12D: 1500 Watts, 120 Volts, 60 Hz., single phase, 12 Amps., 15 Amp. service.
- For H137SUA6D: 1000 Watts, 120 Volts, 60 Hz., single phase, 8.3 Amps., 15 Amp. service.

SHORT FORM SPECIFICATIONS

Cres Cor Insulated Hot Cabinet Model H-137-SUA-___D. Solid state electronic controlled time and temperatures. Cabinet 22 ga. stainless steel; stainless steel internal frame. (___) sets locking transport angles for multiple pan sizes, adjustable spacing every 1-1/2". Dutch doors, 22 ga. stainless steel. Fiberglass insulation in sides, 2"; doors, base, top 1-1/2". Interior coved corners. 1500 or 1000 Watt, 120 Volt power unit. One piece insulated base, .125 aluminum. 6" modulus casters, ball bearings. Load capacity 450 lbs. each. 3-Year Parts / 1-Year Labor warranty. Provide the following accessories: _____ NSF, CSA-US, CSA-C listed. Energy Star Qualified.

In line with its policy to continually improve its products, CRES COR reserves the right to change materials and specifications without notice.



Scan QR code to view Spec Sheet, Operating Manual, Wiring Diagram or to call Customer Service.

If you need a QR reader visit your App Store on your Smartphone or Tablet.



5925 Heisley Road • Mentor, OH 44060-1833
Phone: 877/CRESCOR • Fax: 440/350-7267
www.crescor.com

© Crescent Metal Products, Inc. 2017 All rights reserved.

Made in America Since 1936